

DIGITAL INTERNAL MEASURING GAGES

DATA
OUTPUT



2932-451

- Measure internal dimensions
- Resolution: 0.001mm/0.00005"
- Accuracy: 5µm
- Repeatability: 1µm
- Movable point stroke: 5mm/0.02"
- Point height is adjustable, h=2-25mm
- CR2032 battery, automatic power off (time is adjustable)
- Data output

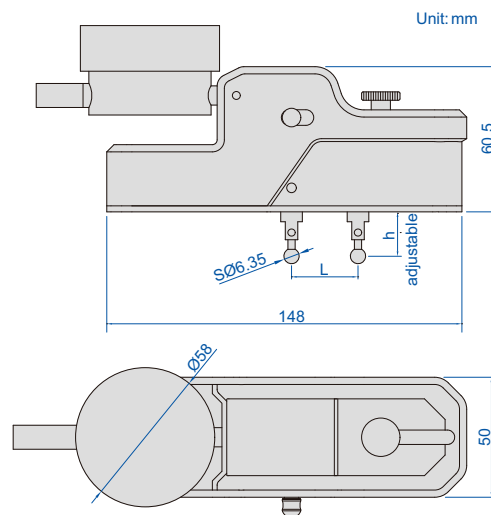

Code	Measuring range (L)	Indicator	Data output cable (optional)
2932-45	20-45mm/0.8-1.8"	Button function: on/off, inch/mm, zero, data preset, change measuring direction, absolute/incremental measurement	7315-50M (need receiver), 7302-40M
2932-451	20-45mm/0.8-1.8"	With transmission button and signal light Reading in digital and analog Display can be rotated by 320° Button function: on/off, inch/mm, zero, data preset, change measuring direction, absolute/incremental measurement, max./min./TIR measurement, tolerance Go and No-Go display	7315-51 (need receiver), 7302-40M

*The measuring range will change accordingly for different measuring points

Disk points (optional, supplied in pair)

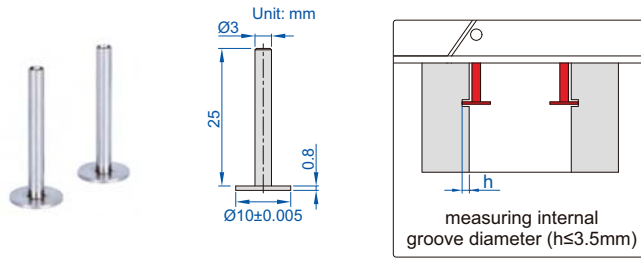

Code	Measuring range	Material
2932-S101	30-55mm/1.2-2.2"	stainless steel

Conical points (optional, supplied in pair)

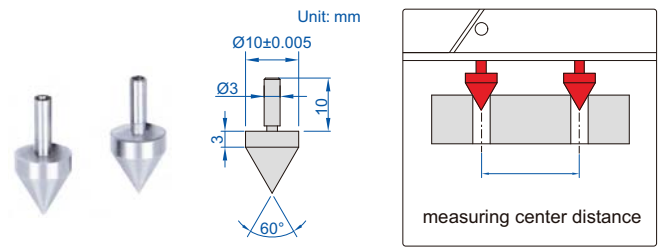

Code	Measuring range	Material
2932-S102	20-45mm/0.8-1.8"	stainless steel

Spherical points (optional, supplied in pair)

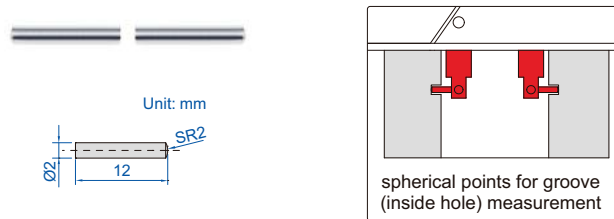

Code	Measuring range	Material
2932-S103	30-60mm/1.2-2.4"	stainless steel

Spherical blade points (optional, supplied in pair)

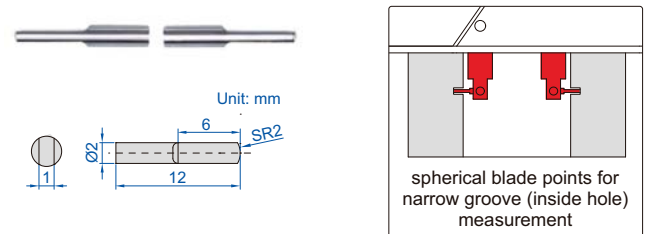

Code	Measuring range	Material
2932-S104	30-60mm/1.2-2.4"	stainless steel

Ball points (optional, supplied in pair)

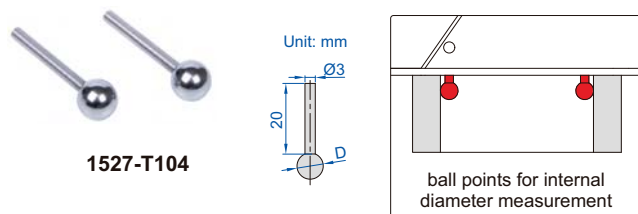

Code	Diameter (D)	Accuracy of diameter	Material
1527-T102	1/8" (Ø3.175mm)	±0.005mm	stainless steel
1527-T103	3/16" (Ø4.7625mm)	±0.005mm	stainless steel
1527-T104	1/4" (Ø6.35mm)	±0.005mm	stainless steel
1527-T105	3/8" (Ø9.525mm)	±0.005mm	stainless steel
1527-T106	1/2" (Ø12.7mm)	±0.005mm	stainless steel

Point sleeve (optional, supplied in pair)



Code
1526-T101

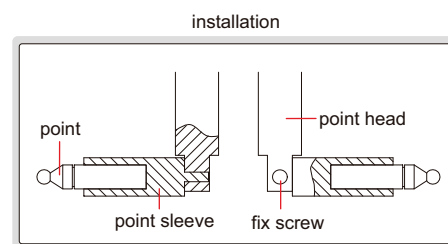

**Screw thread points
(optional, supplied in pair)**



7321-T16

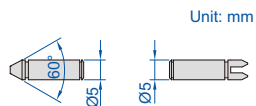

Internal thread (60° thread angle)

Code	Pitch
7321-T11*	0.4-0.5mm/64-48TPI
7321-T12*	0.6-0.9mm/44-28TPI
7321-T13*	1-1.75mm/24-14TPI
7321-T14*	2-3mm/13-9TPI
7321-T15*	3.5-5mm/8-5TPI
7321-T16*	5.5-7mm/4.5-3.5TPI
7321-T1S*	6 pairs/set, including all above points

* It is necessary to use point sleeve (code **1526-T101**) for these points

Measuring range**

80-105mm/3.2-4.2"

** After installing points and point sleeve

Multifunctional points (optional, supplied in pair)



7392-T1



7392-T5



7392-T9



7392-T2



7392-T6



7392-T3



7392-T7



7392-T4



7392-T8

Measuring range**

80-105mm/3.2-4.2"

** After installing points and point sleeve

Code	Type
7392-T1*	flat
7392-T2*	spherical
7392-T3*	spline
7392-T4*	disk
7392-T5*	blade
7392-T6*	knife-edge
7392-T7*	point
7392-T8*	knife-edge
7392-T9*	point

* It is necessary to use point sleeve (code **1526-T101**) for these points

Ball points (optional, supplied in pair)



7391-T5

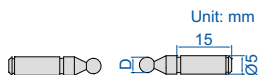

Measuring range**

80-105mm/3.2-4.2"

** After installing points and point sleeve

Code	Ball dia. (D)
7391-T2*	SØ1.5mm
7391-T3*	SØ2.0mm
7391-T4*	SØ2.5mm
7391-T5*	SØ3.0mm
7391-T6*	SØ3.5mm
7391-T7*	SØ4.0mm
7391-T8*	SØ4.5mm
7391-T9*	SØ5.0mm
7391-T10*	SØ6.0mm

* It is necessary to use point sleeve (code **1526-T101**) for these points